

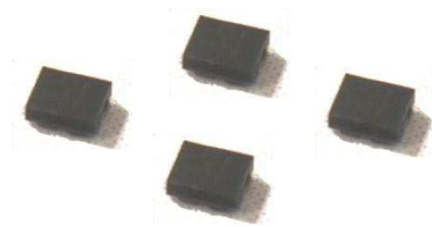

## Data Sheet of SAW Components



Note : This Murata SAW Component is Consumer grade product and applicable for Cellular phone or similar end devices.  
Please also read Important Notice at the end of this document.

# SAW FILTER FOR BAND1/BAND4 Rx

## Murata part number : SAFFB2G14AA0F0A

### Package Dimensions

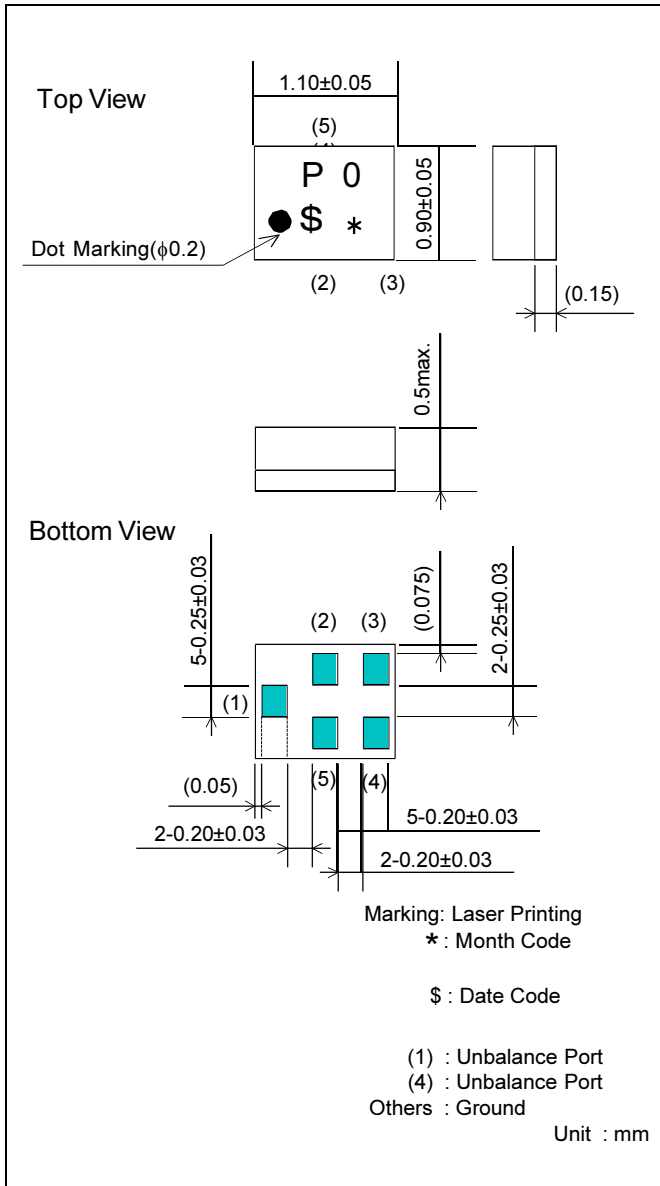

### Specification

Item	Specification		
	-30 to 85°C	25±2°C	typ.
Nominal Center Frequency( $f_c$ )	2140MHz		
Insertion Loss			
1) 2110 to 2170 MHz	3.0 dB max.	2.5 dB max.	1.4 dB
Absolute Attenuation			
1) 10 to 1920 MHz	33 dB min.	33 dB min.	38 dB
2) to 190 MHz	50 dB min.	50 dB min.	56 dB
3) to 400 MHz	47 dB min.	47 dB min.	50 dB
4) 699 to 716 MHz	40 dB min.	40 dB min.	45 dB
5) 777 to 787 MHz	40 dB min.	40 dB min.	45 dB
6) 810 to 830 MHz	42 dB min.	42 dB min.	44 dB
7) 814 to 849 MHz	40 dB min.	40 dB min.	44 dB
8) 824 to 894 MHz	42 dB min.	42 dB min.	44 dB
9) 880 to 915 MHz	40 dB min.	40 dB min.	44 dB
10) 898 to 925 MHz	42 dB min.	42 dB min.	45 dB
11) 1710 to 1755 MHz	43 dB min.	43 dB min.	46 dB
12) 1730 to 1920 MHz	38 dB min.	38 dB min.	40 dB
13) 1920 to 1980 MHz	41 dB min.	41 dB min.	46 dB
14) 2015 to 2075 MHz	10 dB min.	10 dB min.	12 dB
15) 2185 to 2300 MHz	2.0 dB min.	2.0 dB min.	2.6 dB
16) 2300 to 2400 MHz	37 dB min.	37 dB min.	41 dB
17) 2400 to 2500 MHz	36 dB min.	36 dB min.	38 dB
18) 4030 to 4150 MHz	31 dB min.	31 dB min.	34 dB
19) 4220 to 4340 MHz	30 dB min.	30 dB min.	33 dB
20) 4340 to 13025 MHz	15 dB min.	15 dB min.	19 dB
21) 4900 to 5950 MHz	26 dB min.	26 dB min.	29 dB
22) 5950 to 6130 MHz	26 dB min.	26 dB min.	28 dB
23) 6330 to 6510 MHz	26 dB min.	26 dB min.	28 dB
24) 8440 to 8680 MHz	20 dB min.	20 dB min.	25 dB
25) 10550 to 10850 MHz	20 dB min.	20 dB min.	23 dB
26) 12660 to 13020 MHz	15 dB min.	15 dB min.	19 dB
Ripple Deviation			
2110 to 2170 MHz	1.2 dB max.	1.2 dB max.	0.7 dB
VSWR			
2110 to 2170 MHz	1.9 max.	1.9 max.	1.6
Unbalance Port Matching Impedance (nominal)	50Ω		
Input Signal Level	10mW (+10dBm), 8000 hours		

# SAW FILTER FOR BAND1/BAND4 Rx

Murata part number : SAFFB2G14AA0F0A

## ■ Frequency Performance

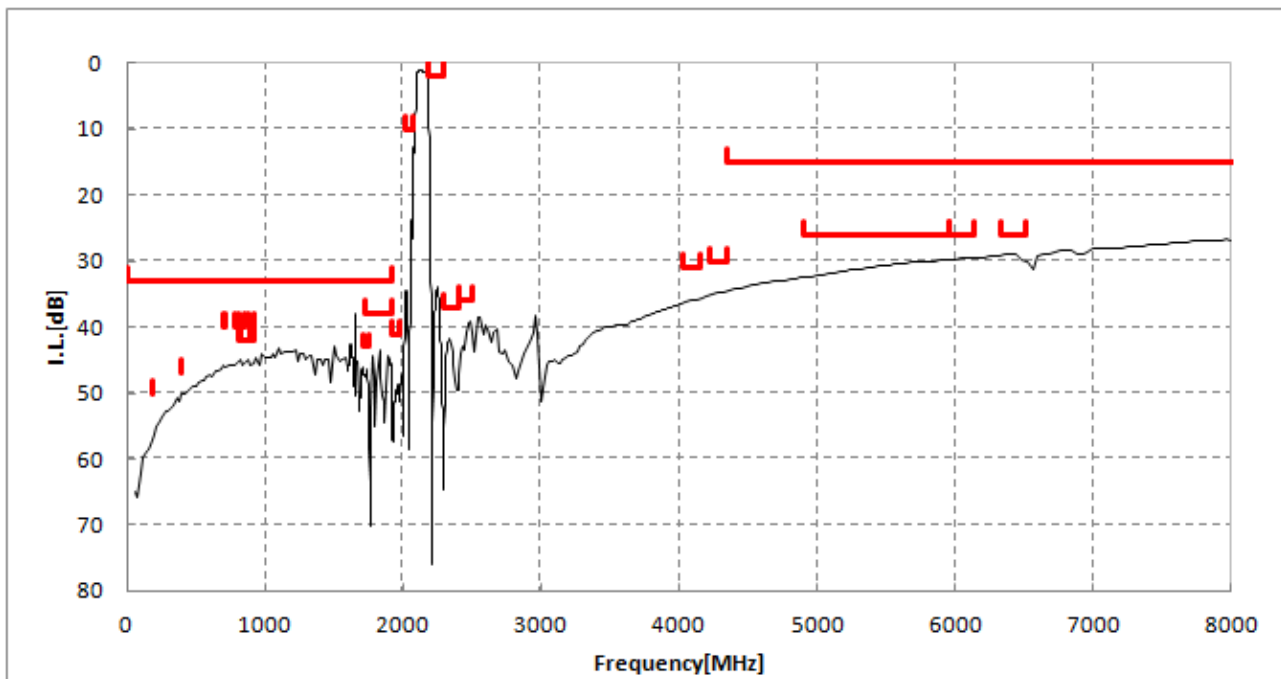
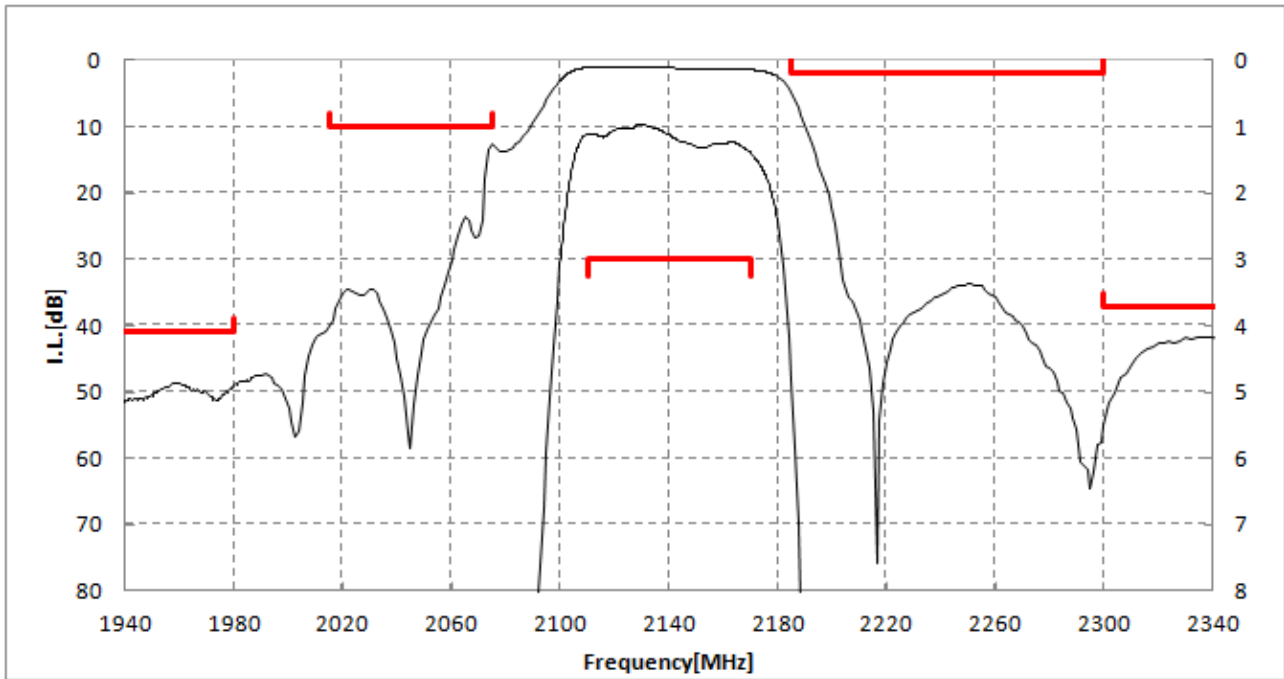

# SAW FILTER FOR BAND1/BAND4 Rx

Murata part number : SAFFB2G14AA0F0A

## ■ Dimensions of Carrier Tape

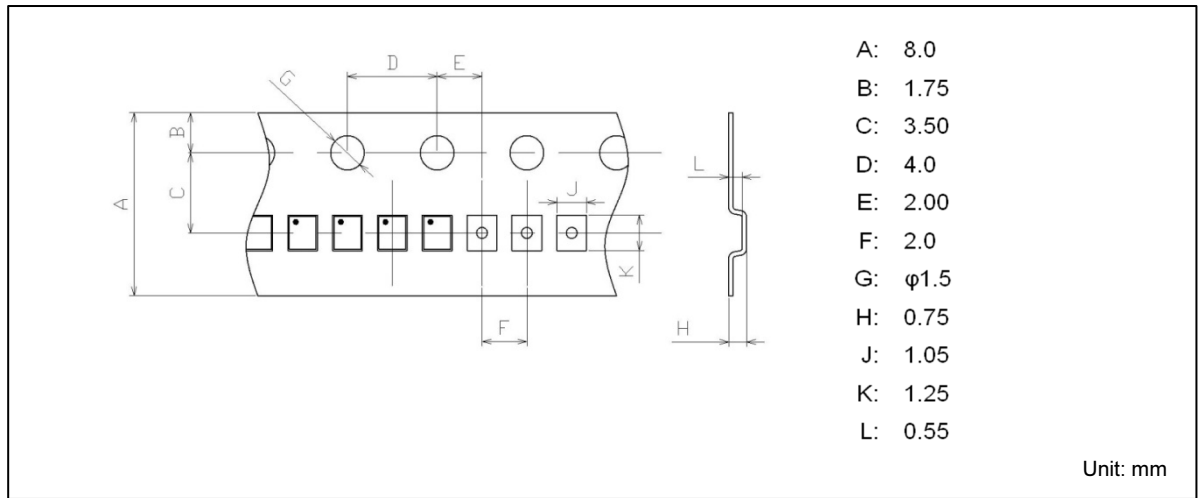

## ■ Dimensions of Tape

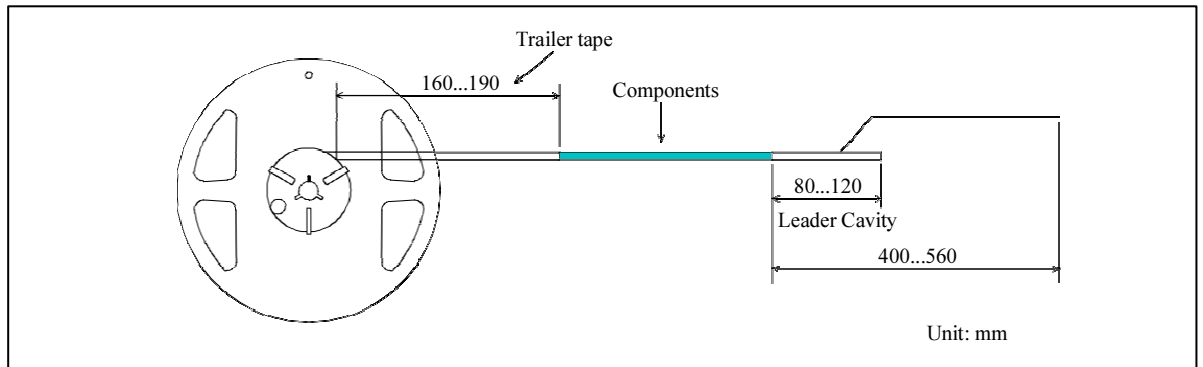

## ■ Dimensions of Reel

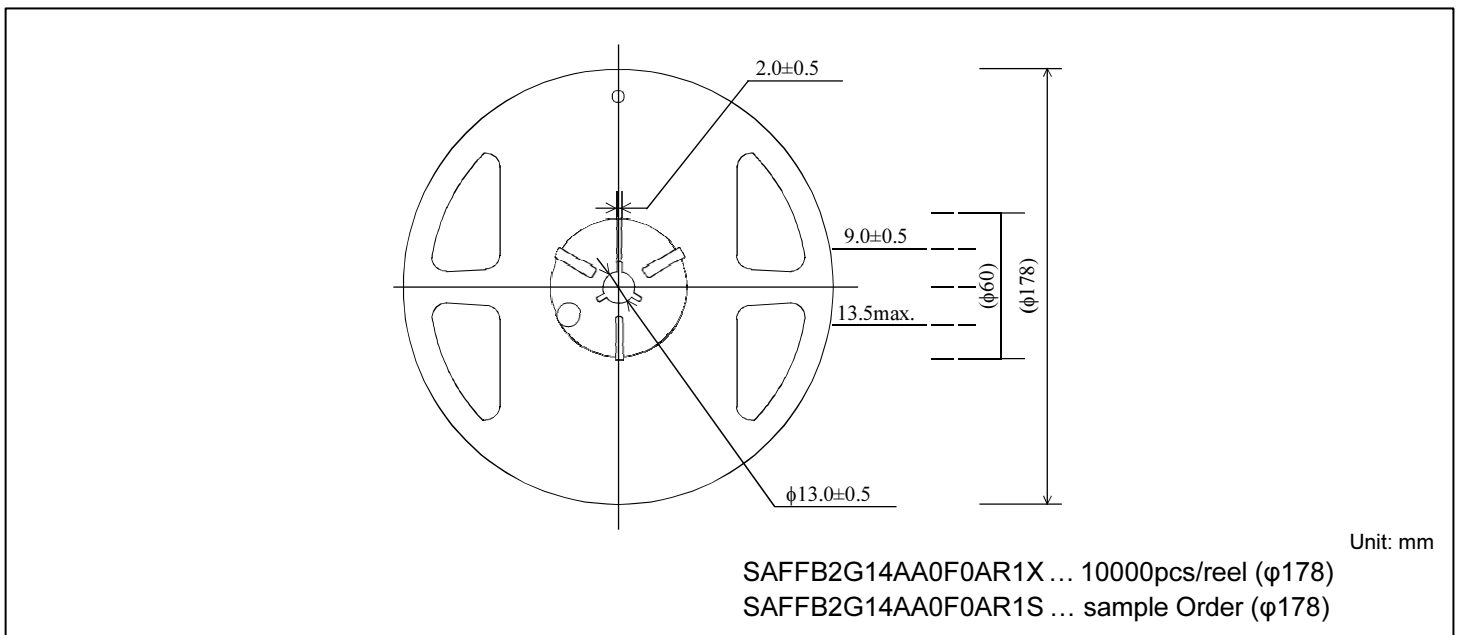

# SAW FILTER FOR BAND1/BAND4 Rx

Murata part number : SAFFB2G14AA0F0A

## Recommended Land Pattern

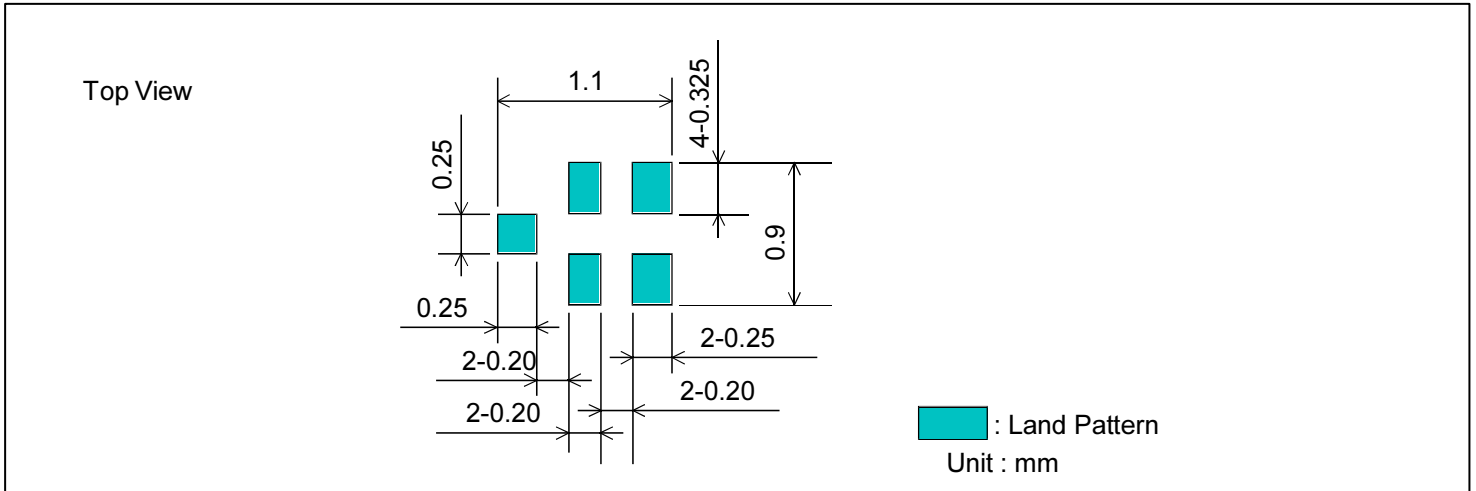

## Test Circuit

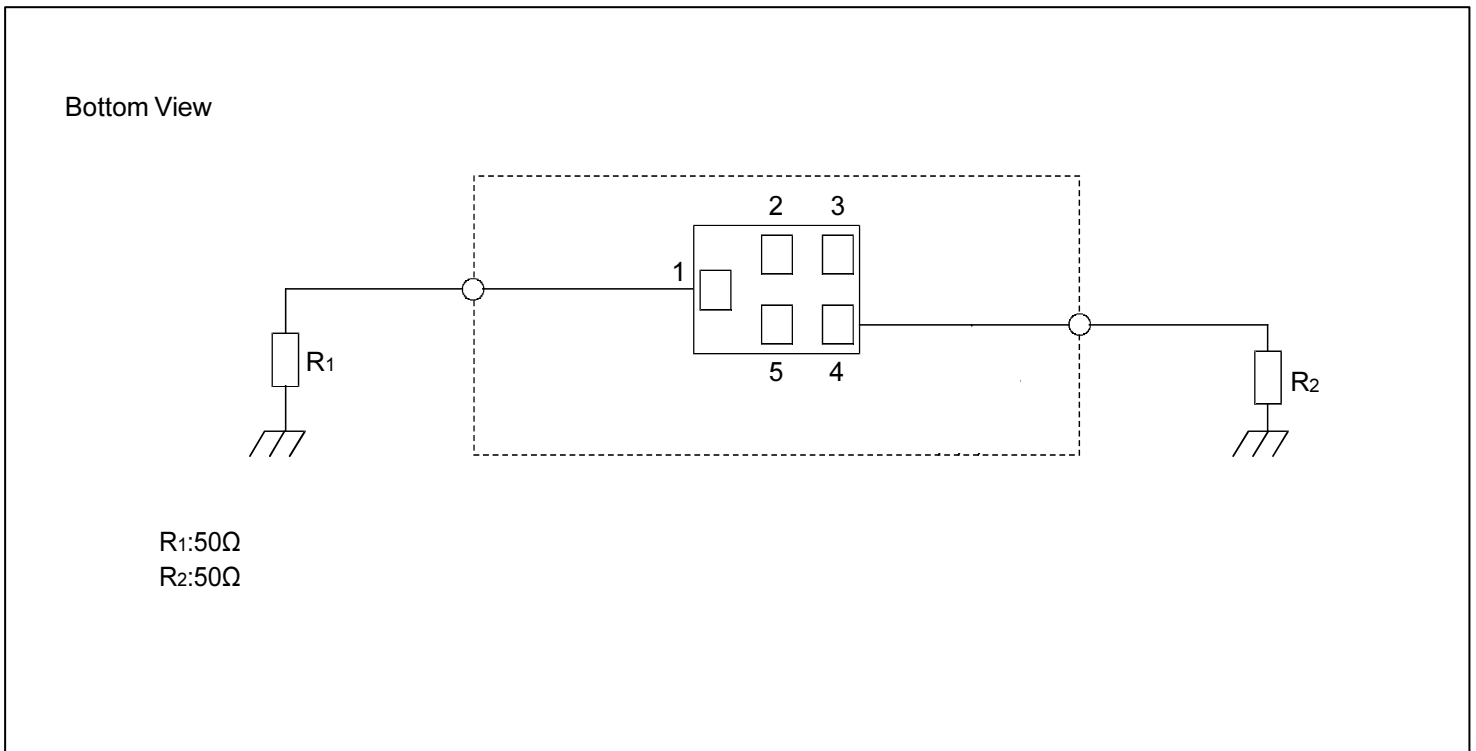

# SAW FILTER FOR BAND1/BAND4 Rx

Murata part number : SAFFB2G14AA0F0A

## ■ RoHS Compliance

This component is compliant with RoHS directive.

This component was always RoHS compliant from the first date of manufacture.

## Caution - Limitation of Applications

This product is intended for the following applications only; however, please do not use this product in these applications where defects might directly cause damage to a third party's life, body or property.

- a. Mobile Telephone
- b. Cordless phone (except for Automotive use)
- c. PC (Including Notebook PC, Netbook PC, Tablet)
- d. Game
- e. Camera (except for Business/security use)
- f. Set Top Box
- g. Electronic dictionary
- h. Digital audio equipment

• This catalog is for reference only and not an official product specification document, therefore, please review and approve our official product specification before ordering this product.

# SAW FILTER FOR BAND1/BAND4 Rx

## Murata part number : SAFFB2G14AA0F0A

### ■ Important notice

Please make sure that your product has been evaluated and confirmed from the aspect of the fitness for the specifications of our product when our product is mounted to your product.

All the items and parameters in this product specification/datasheet/catalog have been prescribed on the premise that our product is used for the purpose, under the condition and in the environment specified in this specification. You are requested not to use our product deviating from the condition and the environment specified in this specification. Please note that the only warranty that we provide regarding the products is its conformance to the specifications provided herein. Accordingly, we shall not be responsible for any defects in products or equipment incorporating such products, which are caused under the conditions other than those specified in this specification.

WE HEREBY DISCLAIM ALL OTHER WARRANTIES REGARDING THE PRODUCTS, EXPRESS OR IMPLIED, INCLUDING WITHOUT LIMITATION ANY WARRANTY OF FITNESS FOR A PARTICULAR PURPOSE, THAT THEY ARE DEFECT-FREE, OR AGAINST INFRINGEMENT OF INTELLECTUAL PROPERTY RIGHTS.

The product shall not be used in any application listed below which requires especially high reliability for the prevention of such defect as may directly cause damage to the third party's life, body or property. You acknowledge and agree that, if you use our products in such applications, we will not be responsible for any failure to meet such requirements. Furthermore, YOU AGREE TO INDEMNIFY AND DEFEND US AND OUR AFFILIATES AGAINST ALL CLAIMS, DAMAGES, COSTS, AND EXPENSES THAT MAY BE INCURRED, INCLUDING WITHOUT LIMITATION, ATTORNEY FEES AND COSTS, DUE TO THE USE OF OUR PRODUCTS IN SUCH APPLICATIONS.

- Aircraft equipment
- Aerospace equipment
- Undersea equipment
- Power plant control equipment
- Medical equipment
- Transportation equipment (vehicles, trains, ships, elevator, etc.)
- Traffic signal equipment
- Disaster prevention / crime prevention equipment
- Burning / explosion control equipment
- Application of similar complexity and/ or reliability requirements to the applications listed in the above

We expressly prohibit you from analyzing, breaking, Reverse-Engineering, remodeling altering, and reproducing our product. Our product cannot be used for the product which is prohibited from being manufactured, used, and sold by the regulations and laws in the world.

Please do not use the product in molding condition

This product is ESD (ElectroStatic Discharge) sensitive device.

When you install or measure this, you should be careful not to add antistatic electricity or high voltage.

Please be advised that you had better check anti serge voltage.

We do not warrant or represent that any license, either express or implied, is granted under any our patent right, copyright, mask work right, or our other intellectual property right relating to any combination, machine, or process in which our products or services are used. Information provided by us regarding third-party products or services does not constitute a license from us to use such products or services or a warranty or endorsement thereof. Use of such information may require a license from a third party under the patents or other intellectual property of the third party, or a license from us under our patents or other intellectual property.

# SAW FILTER FOR BAND1/BAND4 Rx

## Murata part number : SAFFB2G14AA0F0A

Please do not use our products, our technical information and other data provided by us for the purpose of developing of mass-destruction weapons and the purpose of military use.

Moreover, you must comply with "foreign exchange and foreign trade law", the "U.S. export administration regulations", etc.

Please note that we may discontinue the manufacture of our products, due to reasons such as end of supply of materials and/or components from our suppliers.

Customer acknowledges that Murata will, if requested by you, conduct a failure analysis for defect or alleged defect of Products only at the level required for consumer grade Products, and thus such analysis may not always be available or be in accordance with your request (for example, in cases where the defect was caused by components in Products supplied to Murata from a third party).

The product shall not be used in any other application/model than that of claimed to Murata.

Customer acknowledges that engineering samples may deviate from specifications and may contain defects due to their development status.

We reject any liability or product warranty for engineering samples.

In particular we disclaim liability for damages caused by

- the use of the engineering sample other than for evaluation purposes, particularly the installation or integration in the product to be sold by you,
- deviation or lapse in function of engineering sample,
- improper use of engineering samples.

We disclaim any liability for consequential and incidental damages.

If you can't agree the above contents, you should inquire our sales.