

ABSTRACT

This user's guide provides information on the correct usage of the test board and an explanation of the test points and the parts on the board. The test board features of the MYMGK1R820 series are configured for fixed frequency synchronous operation. The test board operates over the entire input voltage range of the MYMGK1R820 series. The minimum input and the output capacitors are included on the board.

Table of Contents

Description	2	Performance Data	7
Performance Summary	3	MYMGK1R820 series EVM Bill of Materials (BOM)	13
Quick Start Guide	4	MYMGK1R820 series EVM Schematic	13
Evaluation Overview	4	EVM PCB Layout	14
Terminal Functions	5	Notices.....	15
Power Input and Output Descriptions	5	 CAUTION	15
Test Point Descriptions	5	Sales Contact.....	15
EVM Connection.....	6	Disclaimers	15
Start-Up Procedure	6	Copyright and Trademark.....	15

Description

This EVM features the MYMGK1R820 series fixed frequency synchronous buck converter switching topology with 4.5 or 8V to 8 or 15V input voltage range. The output voltage is fixed 1.0V but it is possible to change output voltage by external resistors. The full output current rating of the device can be supplied by the EVM.

Input and output capacitors are mounted on the board to accommodate the entire range of input and output voltages. Monitoring test points are provided to allow measurement of voltage, efficiency, power dissipation and load regulation.

The control switch and component footprints are provided for use of the ON/OFF, PWGOOD(Power good signal output), and Remote Sensing(+) features of the module.

The EVM uses a recommended PCB layout that minimizes output ripple and noise. Detailed application information for MYMGK1R820 series is available in the datasheet.



Figure 1. Evaluation Board

Performance Summary

Table 1. Performance Summary

Parameter	Symbol	Conditions	Min	Typ	Max	Units	
INPUT SUPPLY							
Input Voltage Range	VIN	MYMGK1R820FRSR	4.5	-	8.0	V	
		MYMGK1R820ERSR	8	-	15		
ON/OFF pin Low Voltage		Operate ON	-0.3	-	0.6	V	
ON/OFF pin High Voltage		MYMGK1R820FRSR	1.8	-	6.3	V	
		MYMGK1R820ERSR	1.8	-	6.3		
OUTPUT							
Output Voltage Adjustable Range	VOUT	IOUT=0 to 20A	0.7	-	1.8	V	
Output Current	IOUT		0	-	20	A	
Efficiency (MYMGK1R820FRSR)	EFF	VIN=5V, IOUT=20A	VOUT=1.8V	-	89.2	-	%
			VOUT=1.0V	-	84.1	-	
VIN=12V, IOUT=20A		VOUT=1.8V	-	87.8	-		
		VOUT=1.0V	-	81.5	-		
Short Circuit Protection	SCP	If the output is shorted to GND, DC-DC converter shall operate in a hiccup mode. After the short circuit event has cleared, the output is automatically brought back into regulation.	-	30	-	A	

Quick Start Guide

Figure 2. highlights the user interface items associated with the EVM.

The VIN power terminals are used for connection to the host input supply and the VOUT power terminals are used for connection to the load. Sense (+/-) test points for both VIN and VOUT, located near the power terminals are intended to be used as voltage monitoring points where voltmeters can be connected to measure VIN and VOUT.

Do not connect these S+ and S- monitoring test points as the input supply or output load connection points.

The Remote ON/OFF control switch located to the center of the device makes available to test the features of the device. The Power-Good signal can be used with the PWGOOD Pin (The PWGOOD pin is pulled up internally). The remote sensing function can be used by connecting the Sense pin to the load point and rejecting R1 resistor.

About the initial EVM, sense pin is connected to the VOUT in the EVM with R1 resistor.

Evaluation Overview

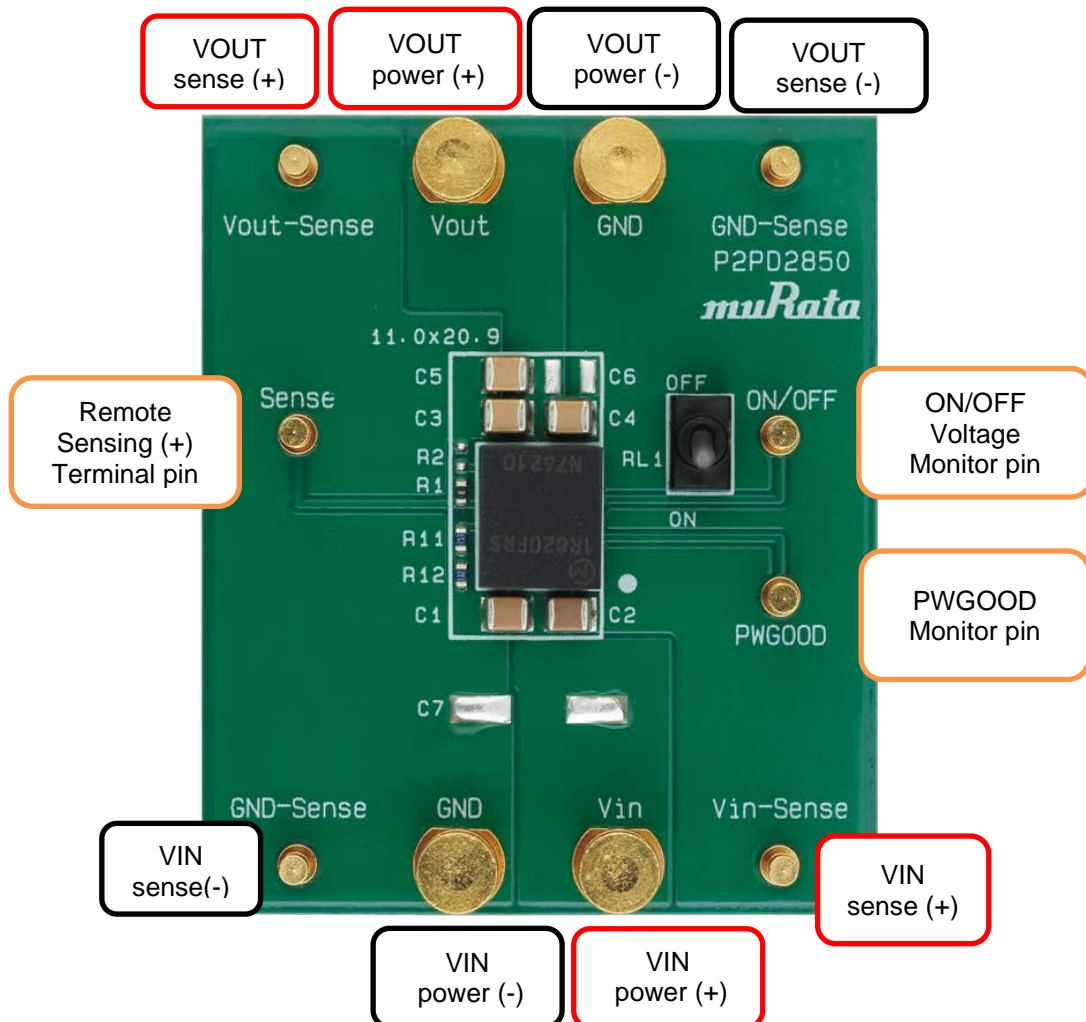

Figure.2 EVM Overview

Terminal Functions

Table 2. Terminal Functions

Function/Terminal	I/O	Description
VIN Power (+/-)	I	Power input pin and input ground pin
VOUT Power (+/-)	O	Power output pin and output ground pin
ON/OFF	-	ON/OFF connection. If this is high level, the module operates. (This pin is pulled up internally)
VIN sense (+/-)	I	Sensing pin for measuring the input voltage
VOUT sense (+/-)	O	Sensing pin for measuring the output voltage
Sense	-	Output Voltage Sensing pin. (It is not a problem to be left open about this pin because it is connected to VOUT internally with 10ohm resistor)
PWGOOD	-	Power good output. (Not open drain, this pin is pulled up to 5.0V internally)

Power Input and Output Descriptions

The VIN power terminals are used to connect to the input supply, and the VOUT power terminal is used to connect to the load.

Caution: Do not use sense (+) and sense (-) terminals as the input supply or output load connection points. The PCB traces connecting to these sense terminals are not designed to support high currents. High currents may cause damage the PCB traces.

Test Point Descriptions

The sense (+) and sense (-) test points for both VIN and VOUT, located near the power terminal are intended to be used as voltage monitoring points where voltmeters can be connected to measure VIN and VOUT.

EVM Connection

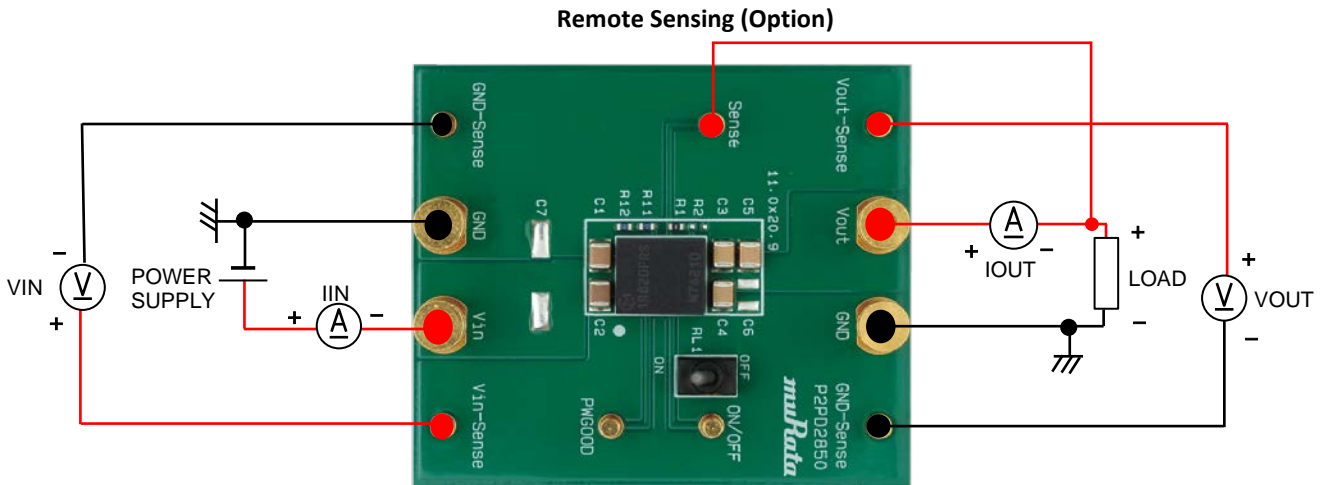

Figure.3

Start-Up Procedure

1. Set the power supply current limit to at least 15A(*FRSR) or 8A(*ERSR). Connect the power supply to VIN power (+) and VIN power (-).
2. Connect one electronic load with more than 20A capacity between VOUT power (+) and VOUT power (-).
3. Set ON/OFF switch off, then turn the load switch off. (Recommend)
4. Set Input voltage to 5V(*FRSR) or 12V(*ERSR) and turn it on.
5. Set ON/OFF switch on, then turn the load switch on. (Recommend)
6. If you need to change the output voltage, please change the R11 and R12 according to the DATA SHEET.

Performance Data of MYMGK1R820ERSR

Figure 4. through Figure 9. demonstrate the MYMGK1R820ERSR* performance. The following test results show the typical performance of the evaluation board.

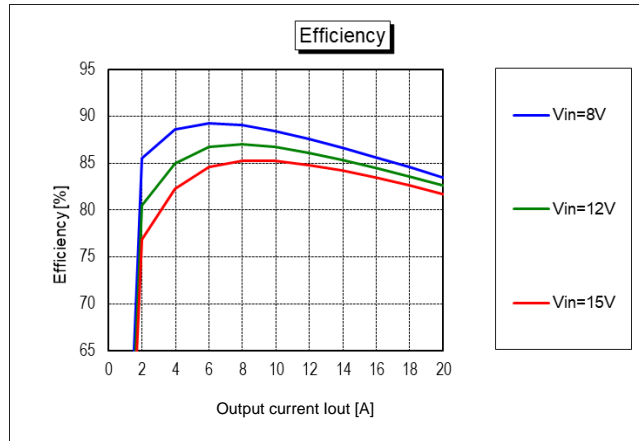

Figure 4. MYMGK1R820ERSR* Efficiency (VOUT=1.0V, Ta=25degC)

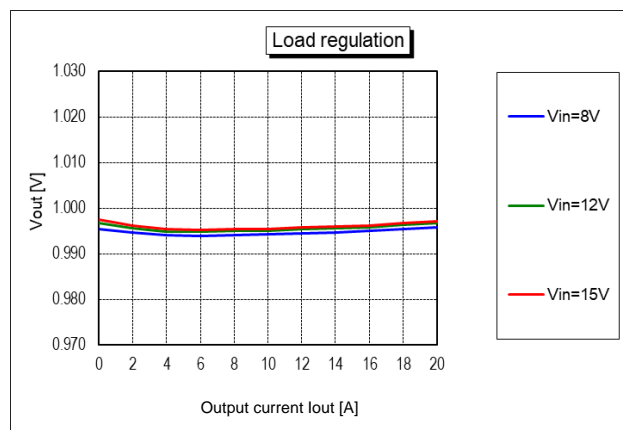

Figure 5. MYMGK1R820ERSR* Output Voltage (VOUT=1.0V, Ta=25degC)

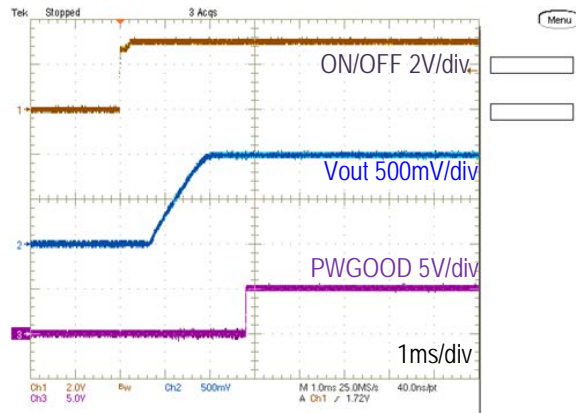

Figure 6. Start-up Waveform

(VIN=12V, VOUT=1.0V, IOUT=20A, Ta=25degC)

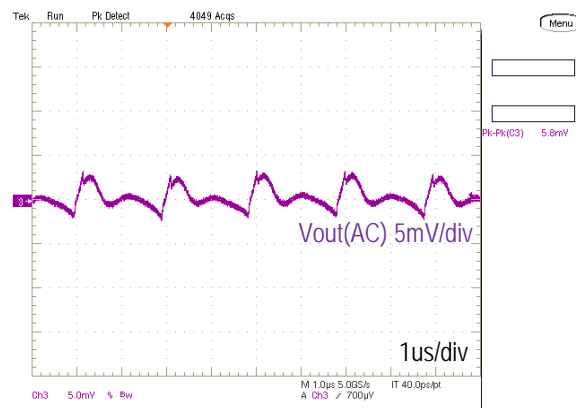

Figure 7. Output Ripple Waveform

(VIN=12V, VOUT=1.0V, IOUT=20A, COUT=660uF, Ta=25degC)

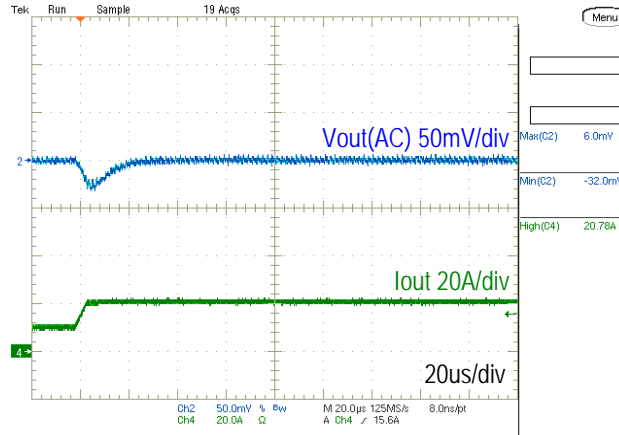

Figure 8. Load Transient Response Waveform

(VIN=12V, VOUT=1.0V, COUT=660uF, IOUT=10 to 20A (2.5A/us), Ta=25degC)

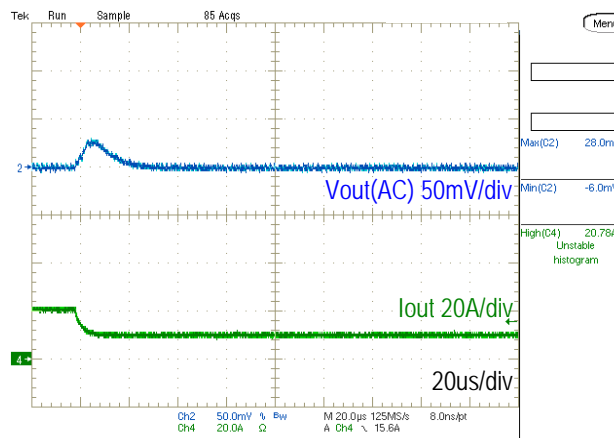

Figure 9. Load Transient Response Waveform

(VIN=12V, VOUT=1.0V, COUT=660uF, IOUT=20 to 10A (2.5A/us), Ta=25degC)

Performance Data of MYMGK1R820FRSR

Figure 10. through Figure 15. demonstrate the MYMGK1R820FRSR* performance. The following test results show the typical performance of the evaluation board.

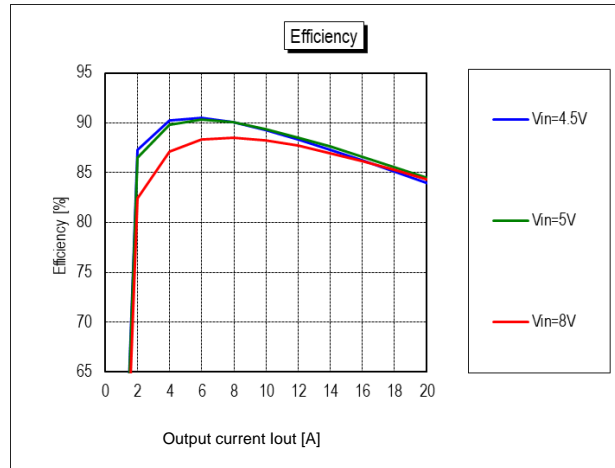

Figure 10. MYMGK1R820FRSR* Efficiency (VOUT=1.0V, Ta=25degC)

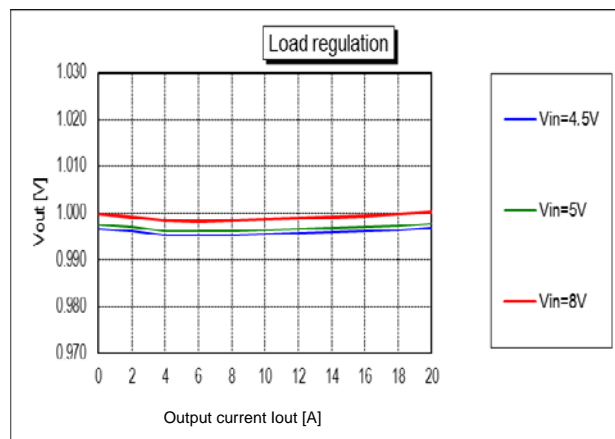

Figure 11. MYMGK1R820FRSR* Output Voltage (VOUT=1.0V, Ta=25degC)

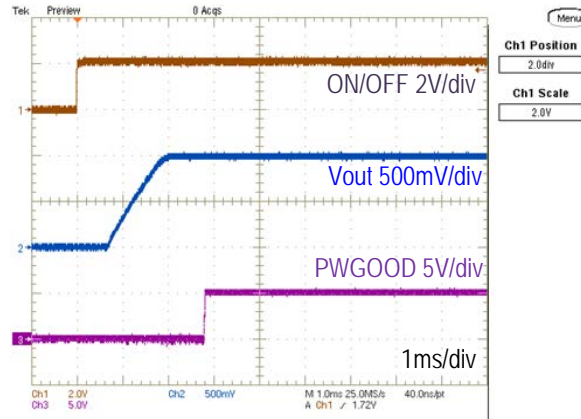

Figure 12. MYMGK1R820FRSR* Start-up Waveform
(VIN=5V, VOUT=1.0V, IOUT=20A, Ta=25degC)

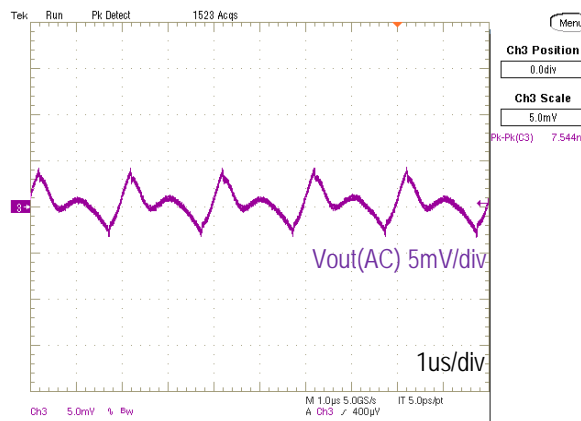

Figure 13. MYMGK1R820FRSR* VOUT Ripple Waveform
(VIN=5V, VOUT=1.0V, IOUT=20A, COUT=660uF, Ta=25degC)

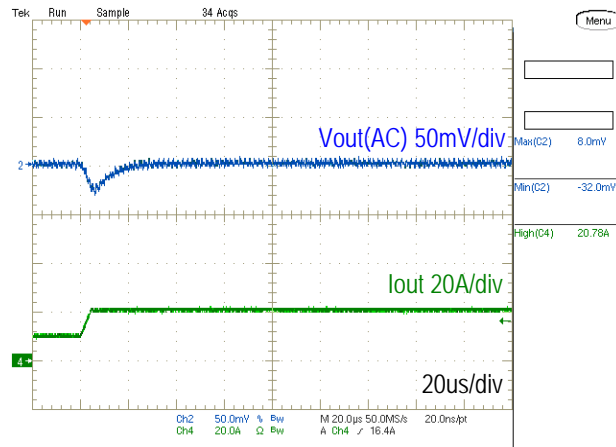

Figure 14. MYMGK1R820FRSR* Load Transient Response Waveform

(VIN=5V, VOUT=1.0V, COUT=660uF, IOU=10 to 20A (2.5A/us), Ta=25degC)

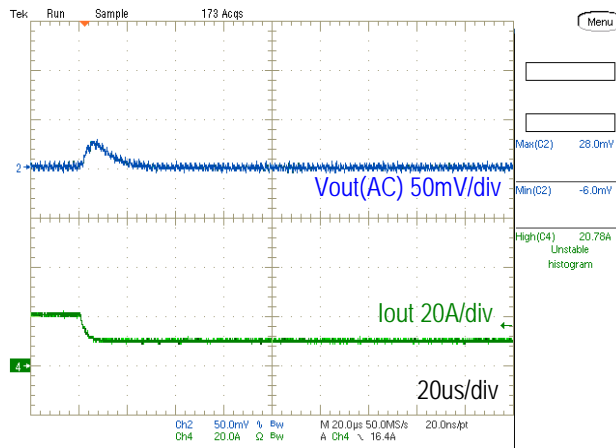

Figure 15. MYMGK1R820FRSR* Load Transient Response Waveform

(VIN=5V, VOUT=1.0V, COUT=660uF, IOU=20 to 10A (2.5A/us), Ta=25degC)

MYMGK1R820 series EVM Bill of Materials (BOM)

Table 3. MYMGK1R820 series EVM Bill of Materials

Reference	Qty	Value	Description	Size	Part Number	Manufacturer
MYMGK1R820FRSR* (Vin=4.5-5.5V)						
C1, C2	2	47uF	Input capacitor 47uF, 10V, +/-10%, X7R	3225M	GRM32ER71A476KE15	Murata
C3, C4, C5	3	220uF	Output capacitor 220uF, 4V, +/-20%, X6S	3225M	GRM32EC80G227ME05	Murata
R11, R12	2	Total 16.3kohm (reference)	Output voltage trimming resistor 0.5%, 1/10W	1608M		KOA
R1	1	0ohm	For short the circuit	1608M	RK73Z1JTDD	KOA
MYMGK1R820ERSR*, MYMGK1R820FRSR* (Vin=8-14V or 5.5-8.0V)						
C1, C2	2	22uF	Input capacitor 22uF, 25V, +/-10%, X7R	3225M	GRM32ER71E226KE15	Murata
C3, C4, C5	3	220uF	Output capacitor 220uF, 4V, +/-20%, X6S	3225M	GRM32EC80G227ME05	Murata
R11, R12	2	Total 15.9kohm (reference)	Output voltage trimming resistor 0.5%, 1/10W	1608M		KOA
R1	1	0ohm	For short the circuit	1608M	RK73Z1JTDD	KOA

MYMGK1R820 series EVM Schematic

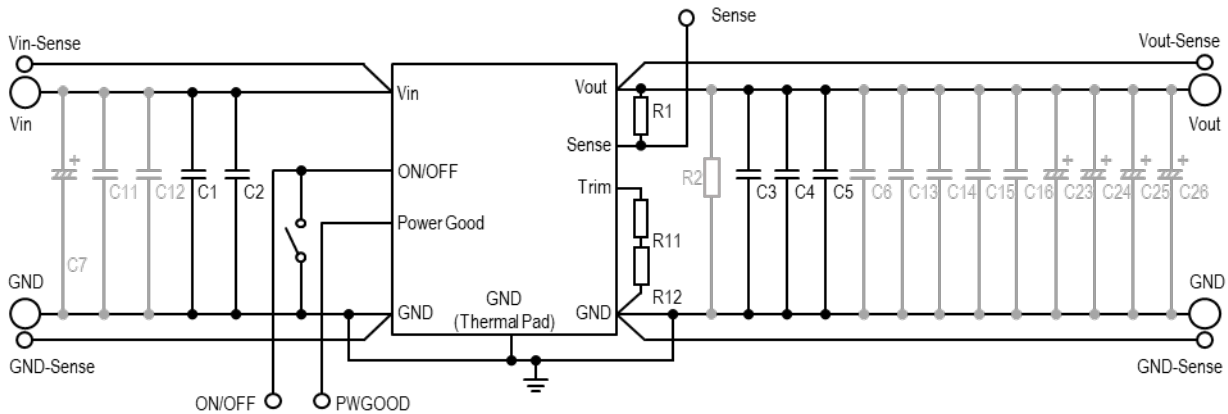

Figure 16. MYMGK1R820 series EVM schematic

EVM PCB Layout

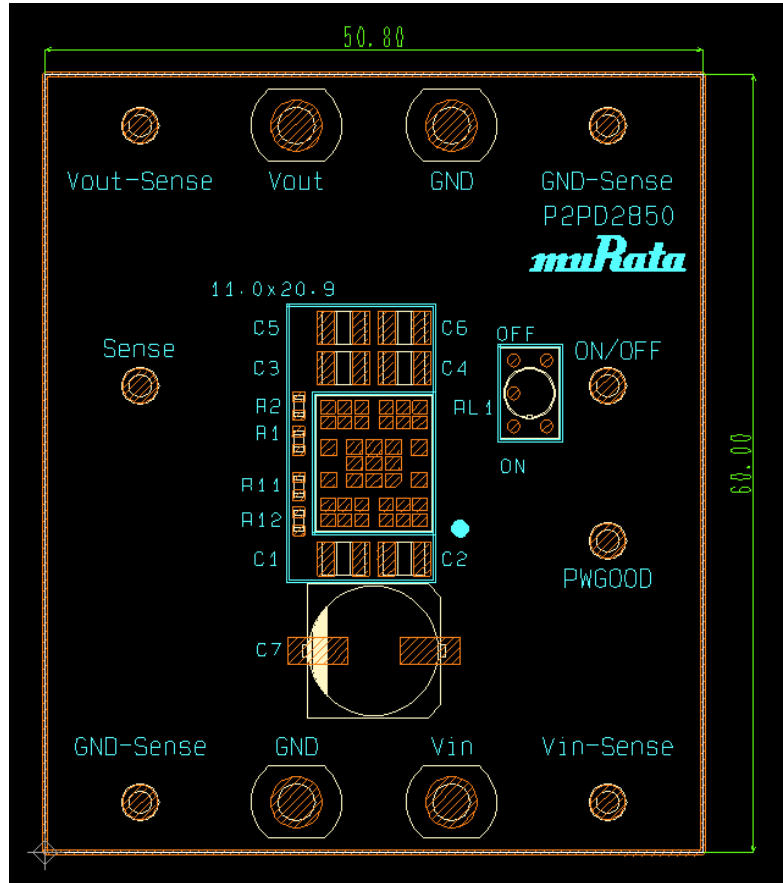

Figure 17. Evaluation Board Layout (Top) Size : mm

Notices

CAUTION

1. EVMs are not finished products. Murata delivers EVM for use in a research and development evaluation purpose only.
2. Please make sure that your product has been evaluated and confirmed to your specifications when our product is used in your product.
3. All the items and parameters in this approval sheet for product specification are based on the premise that our product is used for the purpose, under the condition and in the environment agreed upon between you and us. You are requested not to use our product in a manner deviating from such agreement.
4. If you have any concerns about materials other than those listed in the RoHS directive, please contact us.
5. Be sure to provide an appropriate fail-safe functionality in your product to prevent secondary damage that could be caused by the abnormal function or failure of our product.
6. Do not allow our product to be exposed to excess moisture under any circumstances.

Contact form

<https://www.murata.com/contactform?Product=Power%20Device>

Disclaimers

The information in this document is believed to be reliable. However, Murata assumes no liability for the use of this information. The use shall be entirely at the user's own risk. No patent rights or licenses to any circuits described in this document are implied or granted to any third party. Murata's products are not designed or intended for use in devices or systems intended for a surgical implant, or in other applications intended to support or sustain life, or in any application in which the failure of the Murata product could create a situation in which personal injury or death might occur. Murata assumes no liability for damages, including consequential or incidental damages, arising out of the use of its products in such applications.

Copyright and Trademark

©2022 Murata Manufacturing Co., Ltd. All rights reserved.



This product is subject to the following [operating requirements](#) and the [Life and Safety Critical Application Sales Policy](#):
Refer to: <https://power.murata.com/en/requirements>

Murata Manufacturing Co., Ltd makes no representation that the use of its products in the circuits described herein, or the use of other technical information contained herein, will not infringe upon existing or future patent rights. The descriptions contained herein do not imply the granting of licenses to make, use, or sell equipment constructed in accordance therewith. Spec and cautions are subject to change without notice. © 2022 Murata Manufacturing Co., Ltd